

Construction

Close-coupled peripheral pumps (regenerative pumps) with turbine impeller.

Applications

For clean liquids without abrasives, without suspended solids, non-explosive, non-aggressive for the pump materials.
For increasing network pressure (follow local specifications).
For the reduced dimensions, these pumps are very well suitable to be mounted in cooling and air-conditioning machines and equipments, circulation, boiler feed.

Operating conditions

Liquid temperature from -10 °C to +90 °C.
Ambient temperature up to 40 °C.
Total suction lift up to 7 m.
Continuous duty.

Motor

2-pole induction motor, 50 Hz (n = 2900 rpm).

T, TP: three-phase 230/400 V ± 10% .

TM, TPM: single-phase 230 V ± 10% with thermal protector.
Capacitor inside the terminal box.

Insulation class F.

Protection IP 54.

Constructed in accordance with: IEC 60034; IEC 60335-1 (EN 60335-1).

Special features on request

- Other voltages.
- Frequency 60 Hz (as per 60 Hz data sheet).
- Protection IP 55.
- Special mechanical seal.
- Higher or lower liquid or ambient temperatures.

Materiales

Components	T, TP	B-T, B-TP
Pump casing	Cast iron	Bronze
Lantern bracket	GJL 200 EN 1561	G-Cu Sn 10 EN 1982
Casing cover	Cast iron	Bronze
	GJL 200 EN 1561	G-Cu Sn 10 EN 1982
	Brass P- Cu Zn Pb 40 2 UNI 5705 for T 61-65-70, B-T 61-70	
Impeller	Brass P- Cu Zn 40 Pb 2 UNI 5705	
	Bronze G-Cu Sn 10 EN 1982 for T 125, TP 132-132R	
Shaft	Cr-Ni steel AISI 303 T 76, Tp 80-100	Cr-Ni-Mo steel AISI 316
	Chrome steel AISI 430 T 61-65-70-100-125, Tp 78-132-132R	
Mechanical seal	Carbon - Ceramic - NBR	

Coverage chart $n \approx 2900$ rpm

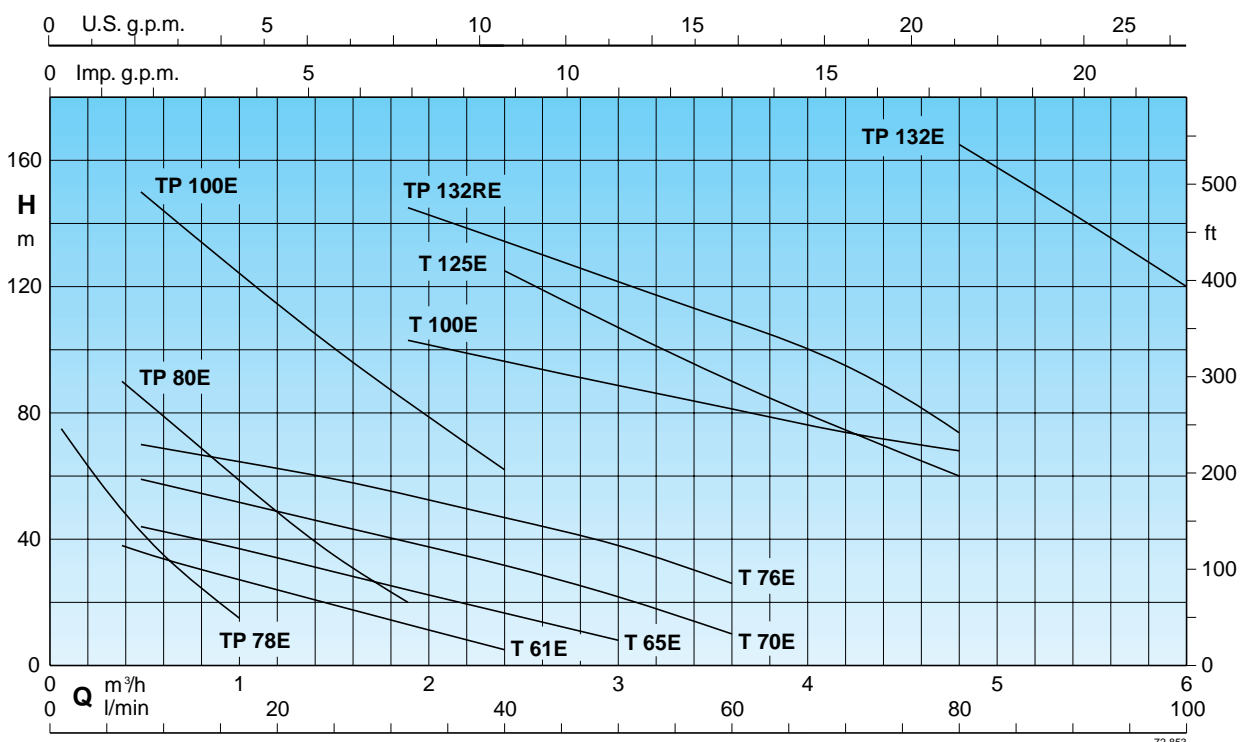

Performance $n \approx 2900$ rpm

	3 ~ 230V 400V		1 ~ 230V		P1		P2		Q m ³ /h l/min																		
	A	A	A	kW	kW	HP	H m	0,06		0,12	0,24	0,38	0,48	0,6	0,75	1	1,2	1,5	1,89	2,4	3	3,6	4,2	4,8	5,4	6	
B- T 61E	1,9	1,1	B- TM 61E	2,5	0,55	0,33	0,45																				
T 65E	2,8	1,6	TM 65E	3,5	0,8	0,45	0,6																				
B- T 70E	3,7	2,2	B- TM 70E	6	1,3	0,75	1																				
T 76E	5,3	3	TM 76E	7,4	1,6	1,1	1,5																				
T 100E	11,5	6,6					3	4																			
T 125E		9,6					4	5,5																			
B- TP 78E	2,3	1,3	B- TPM 78E	2,8	0,6	0,37	0,5		75	70	60	50	42	35	25	15											
B- TP 80E	4	2,3	B- TPM 80E	5,8	1,2	0,75	1					90	85	79	73	61	48	34	20								
TP 100E	9,6	5,5					2,2	3					150	144	136	125	115	100	84	62							
TP 132RE		12					5,5	7,5																			
TP 132E		16					7,5	10																			

P1 Maximum power input.

B-T, B-TM = Bronze construction.

H Total head in m.

* Maximum suction lift 2-3 m.

P2 Rated motor power output.

Dimensions and weights

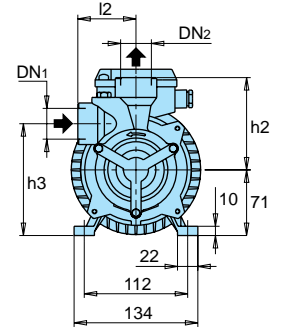
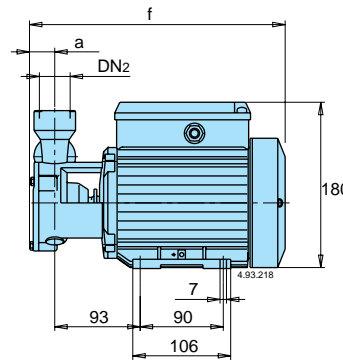
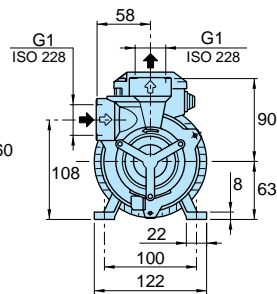
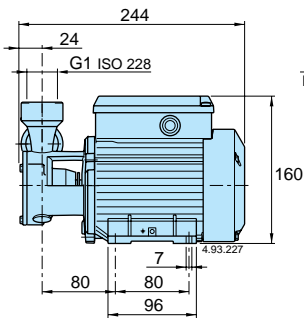

T 61E: kg 6,3
B- T 61E: kg 6,5
T 65E: kg 6,3

TYPE	DN1 ISO 228	DN2 ISO 228	mm					kg	
			a	f	h2	h3	l2	T	B-T
T 70E B-T 70E	G 1	G 1	24	278	100	121	63	11,2	11,6
TP 78E B-TP 78E	G 1/2	G 1/2	22	276	80	127	56	8,2	8,8

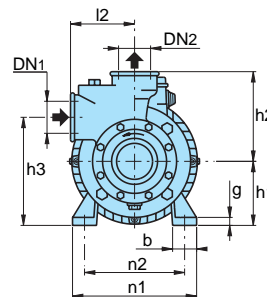
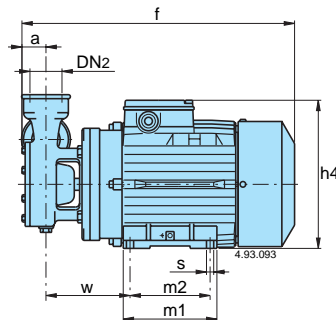

TYPE	DN1 ISO 228	DN2 ISO 228	mm														kg			
			a	f	h1	h2	h3	h4	m1	m2	n1	n2	b	s	l1	l2	w	g	T, TP	B-TP
T 76E	G 1 1/4	G 1 1/4	26	338	80	112	136	185	117	100	155	125	30	9	-	80	105	10	18,4	-
T 100E	G 1 1/4	G 1 1/4	32	410	90	130	161	216	152	125	180	140	40	9,5	-	95	121	12	29,5	-
T 125E	G 1 1/4	G 1 1/4	32	470	90	155	170	216	152	125	180	140	40	9,5	-	90	195	12	39	-
TP 80E B-TP 80E	G 3/4	G 3/4	27	332	80	90	135	185	117	100	155	125	30	9	-	60	104	10	16,4	16,8
TP 100E	G 3/4	G 3/4	27	347	80	100	142	185	117	100	155	125	30	9	-	65	113	10	21,3	-
TP 132RE	G 1 1/4	G 1 1/4	42	485	112	160	202	272	180	140	230	190	50	11,5	-	100	183	14	52,6	-
TP 132E	G 1 1/4	G 1 1/4	42	485	112	160	202	272	180	140	230	190	50	11,5	-	100	183	14	58	-

Characteristic curves $n \approx 2900$ rpm

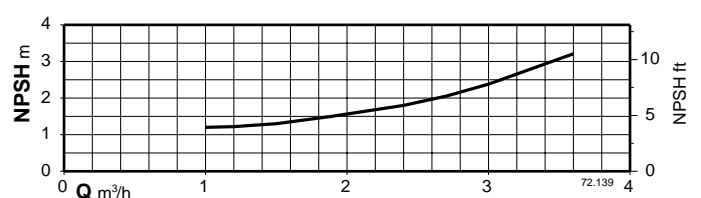
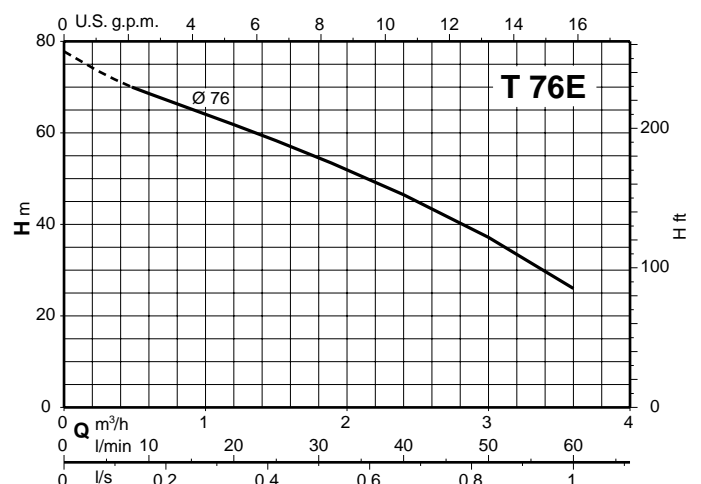
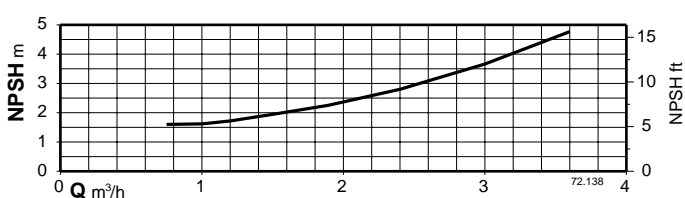
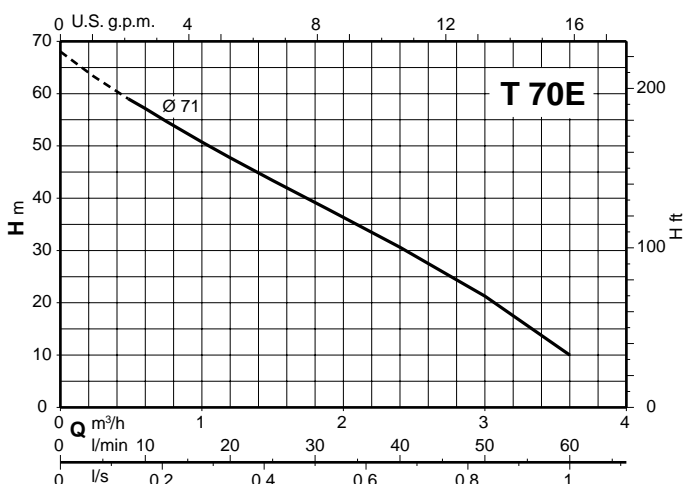
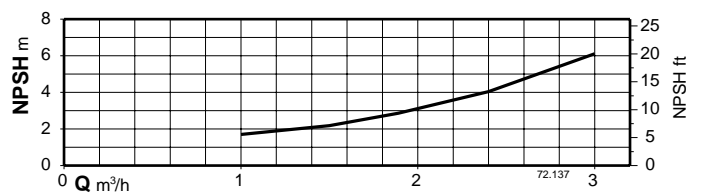
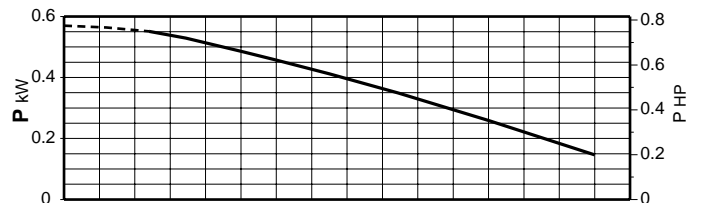
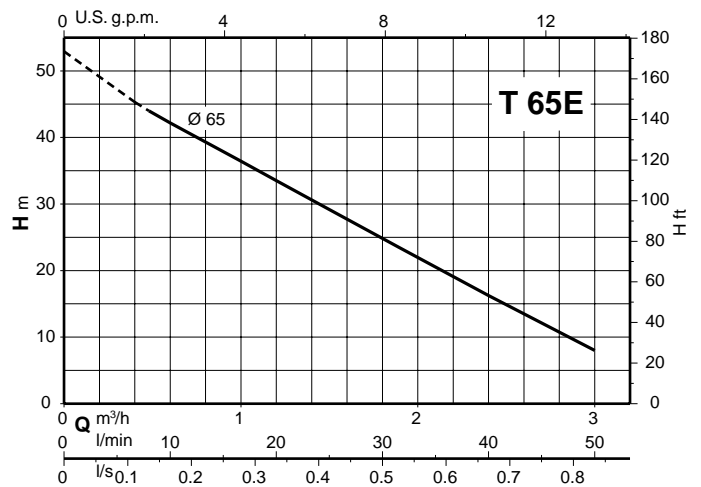
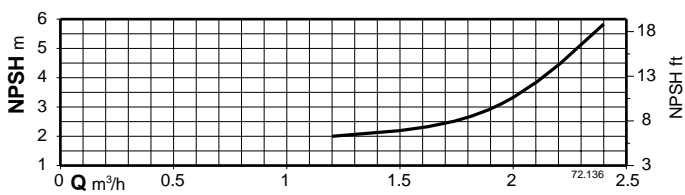
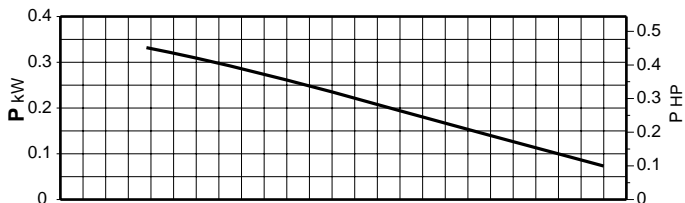
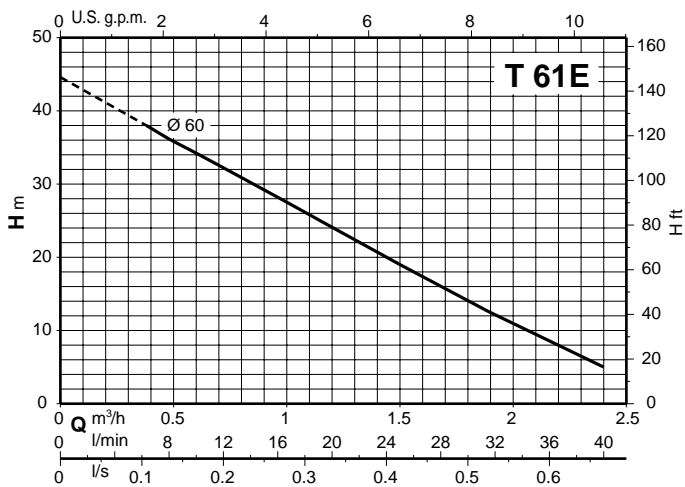

Characteristic curves $n \approx 2900$ rpm

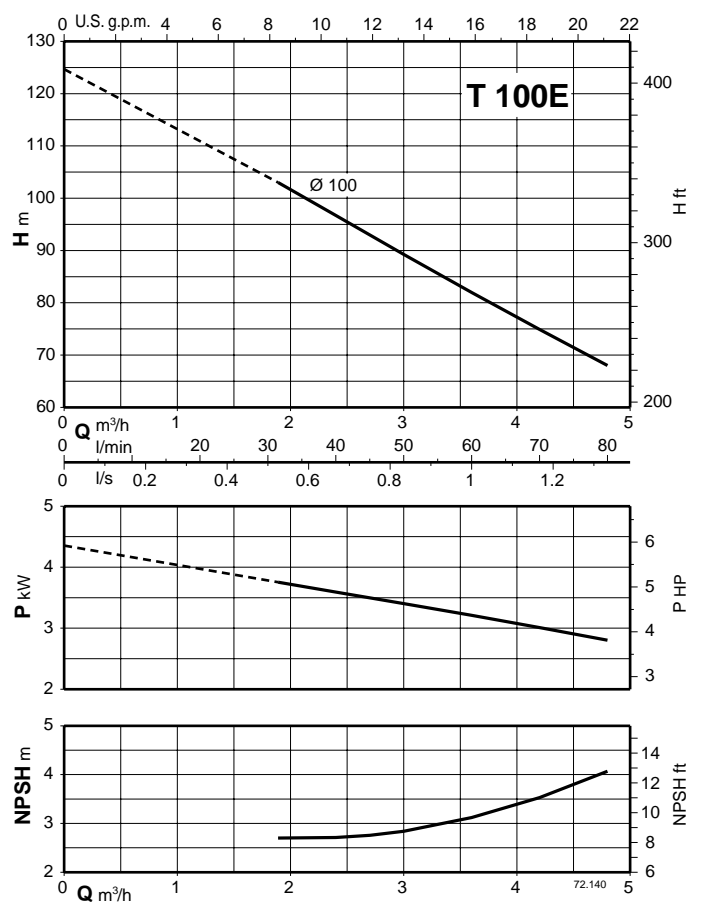
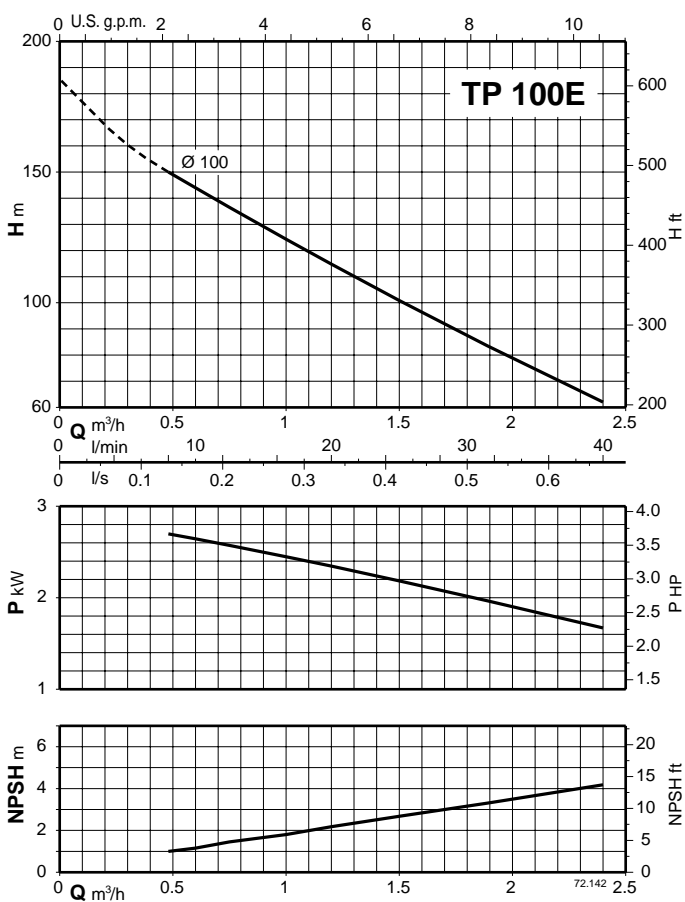
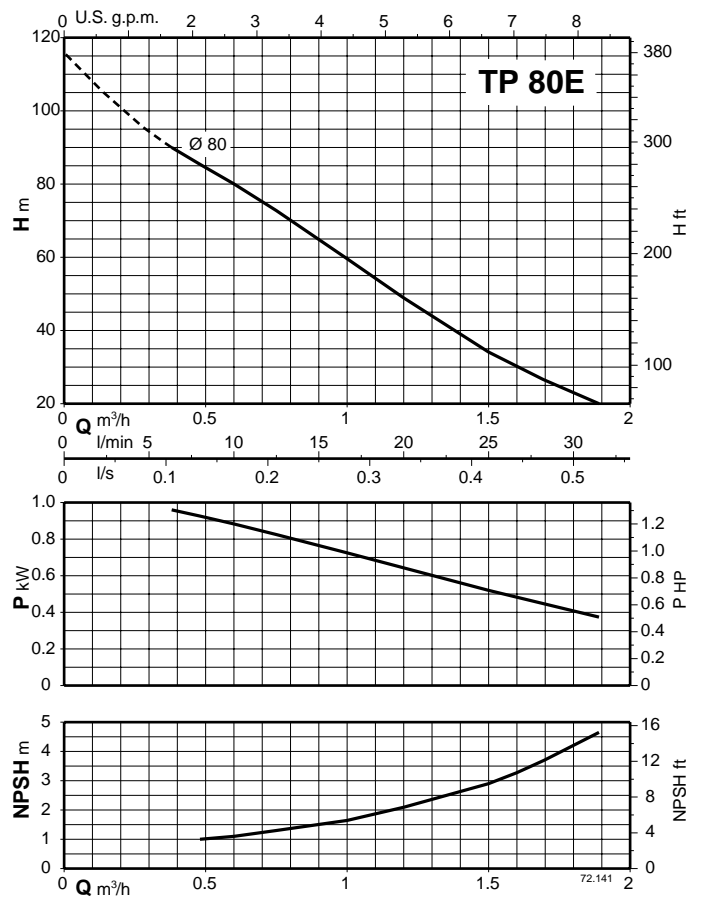
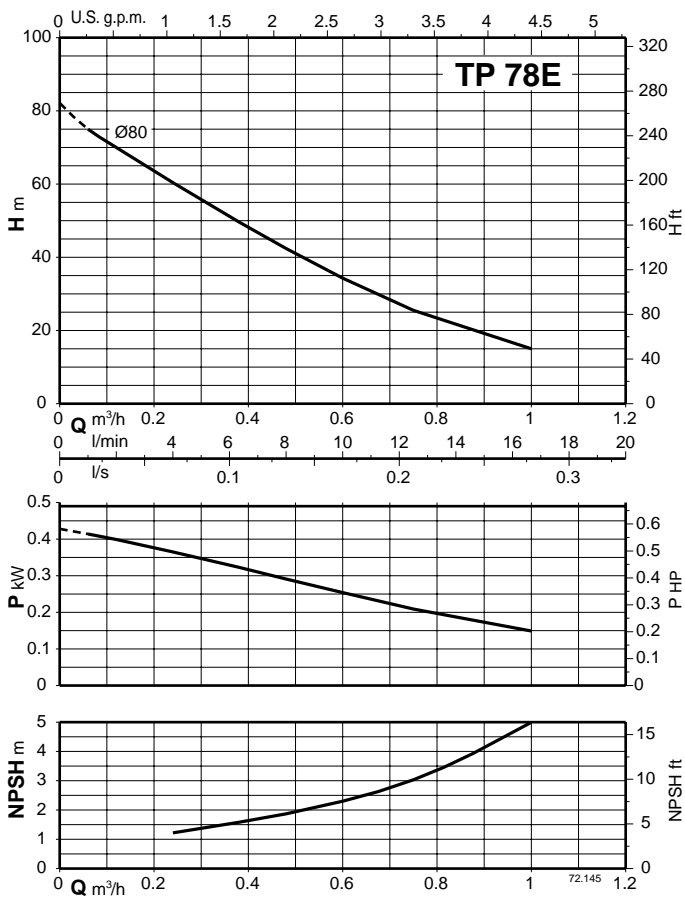

Characteristic curves $n \approx 2900$ rpm

